

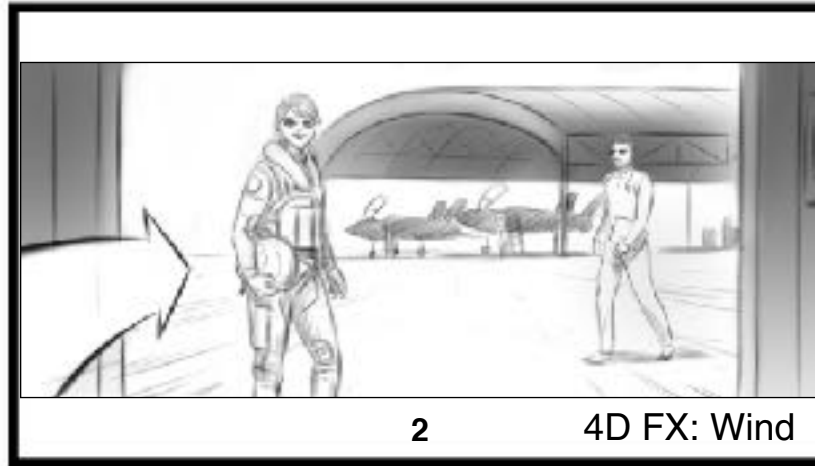

INT. AIR FORCE BASE. Our PILOT in front of a mirror...

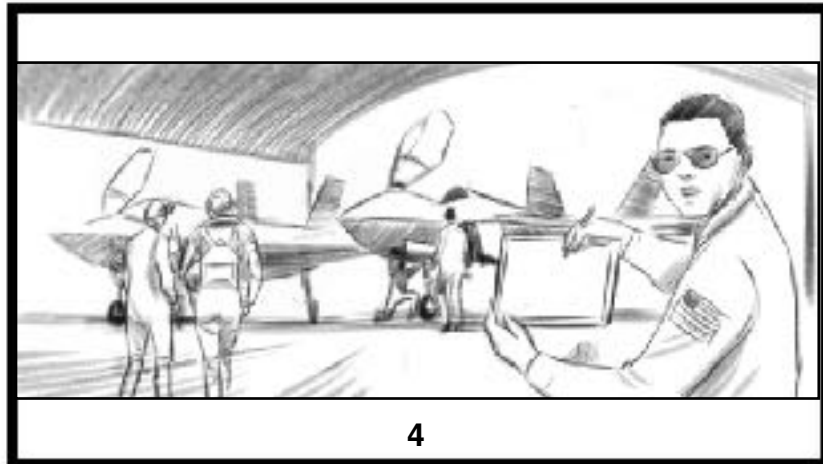

OUR PILOT is joined by a SECOND PILOT, walking toward a pair of F-35s under a brightly lit hangar – until we're joined by a MISSION COMMANDER, who briefs us directly on the task ahead.

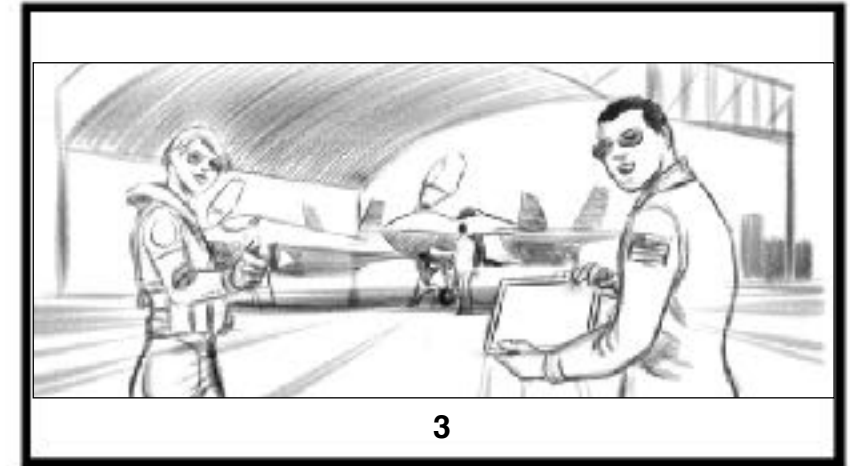

COMMANDER: Here's what we got. Several aid workers have been taken hostage by a rebel group. You'll provide close-air support while a Spec Ops team goes in and gets them out. Good luck.

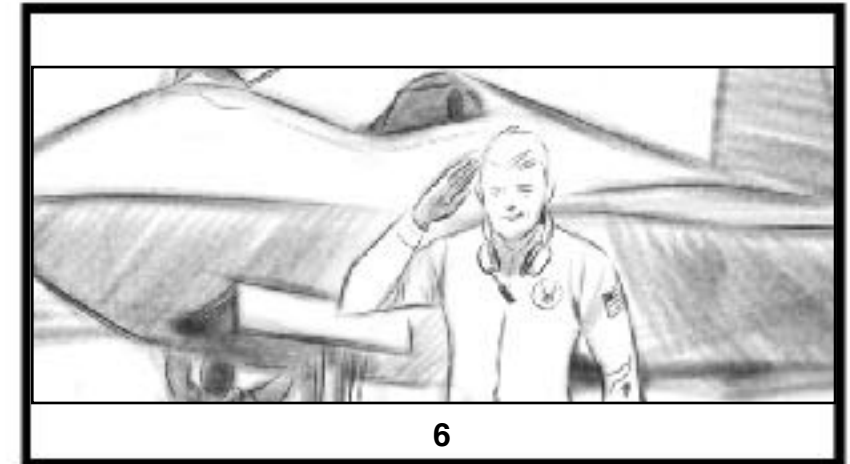
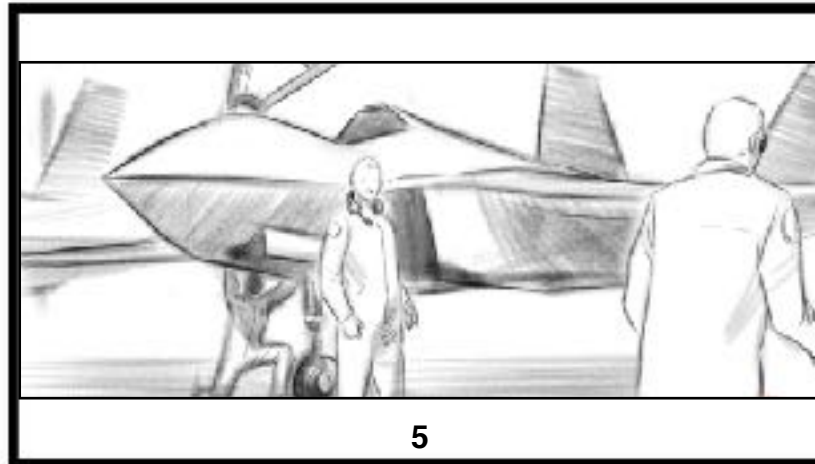

PILOT: Any issues I should know about?

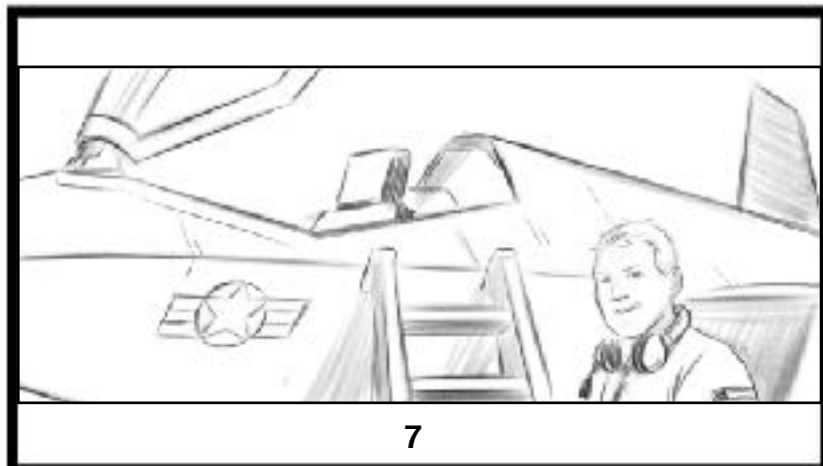

CREW CHIEF: All good. It's still got that new-plane smell.

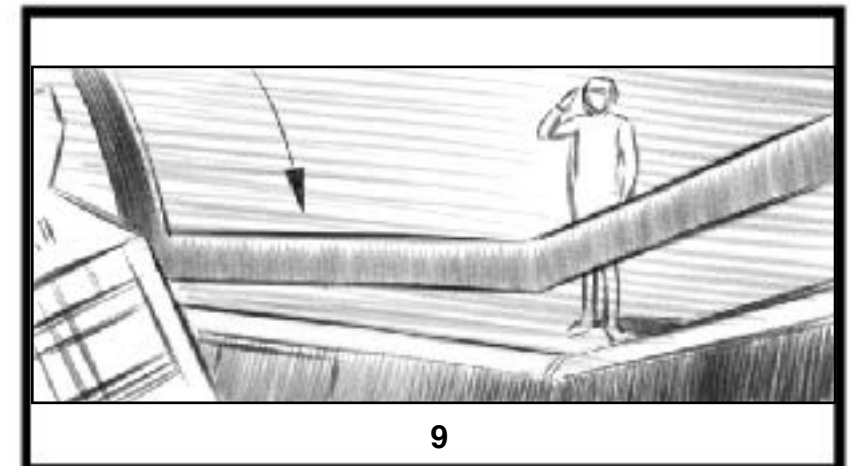
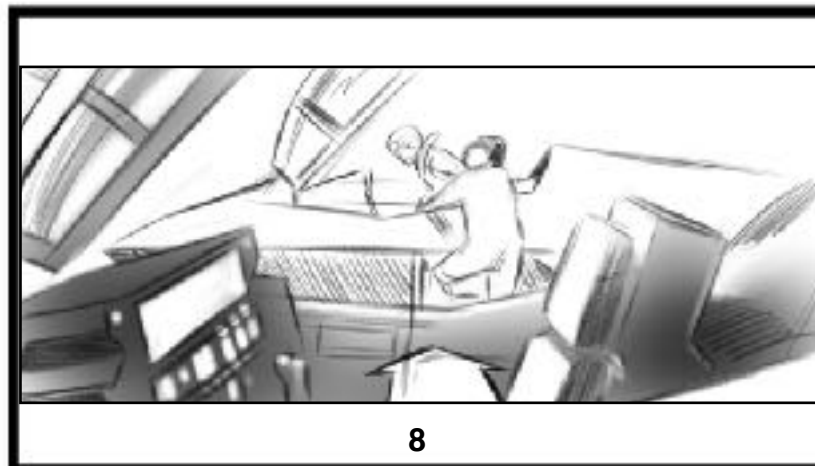

Then, with a final salute...

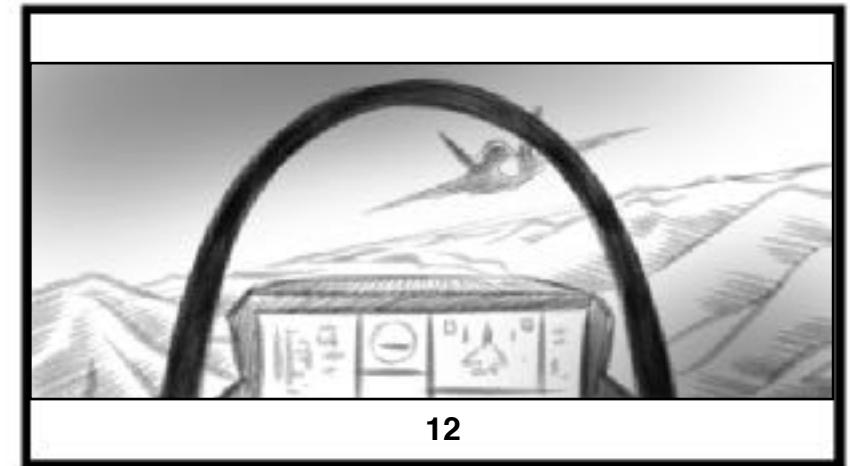
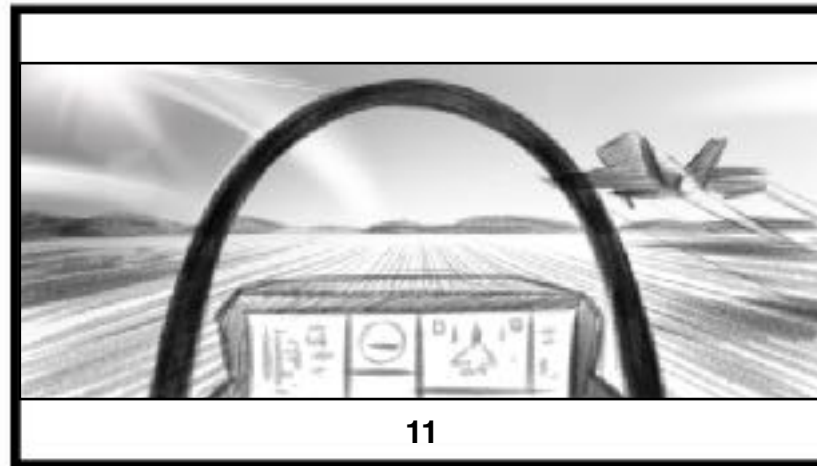
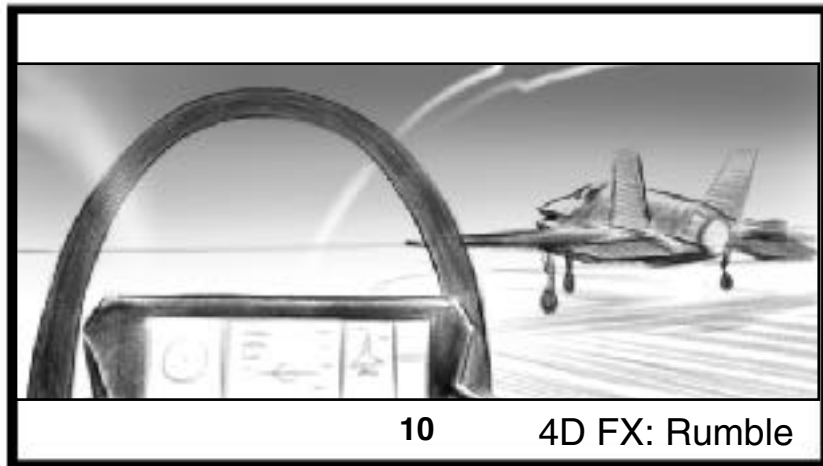

... we BLAST down THE RUNWAY—alongside our wingman/woman in a second F35—taking off into the sky...

WINGWOMAN: See if you can keep up!

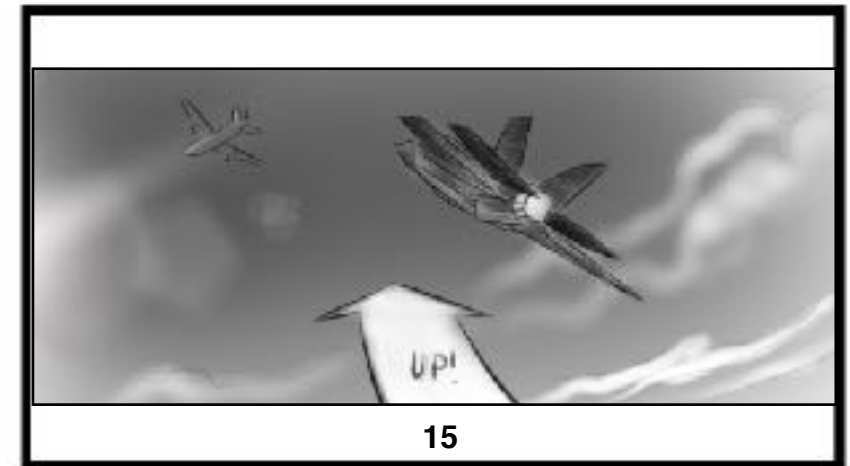
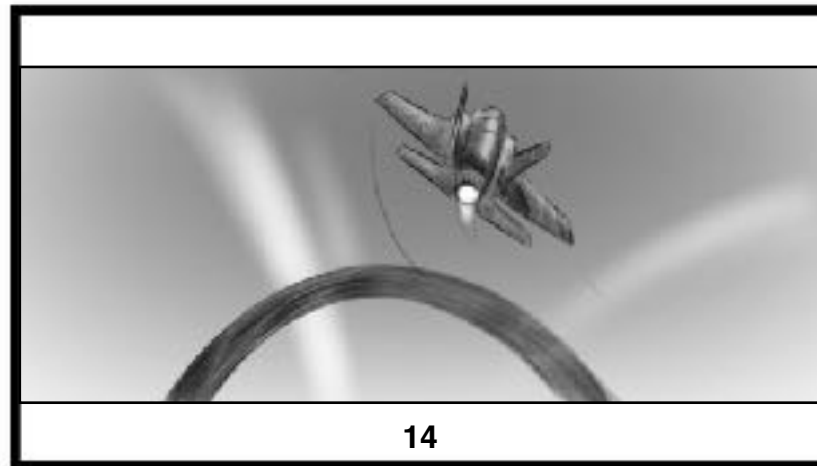
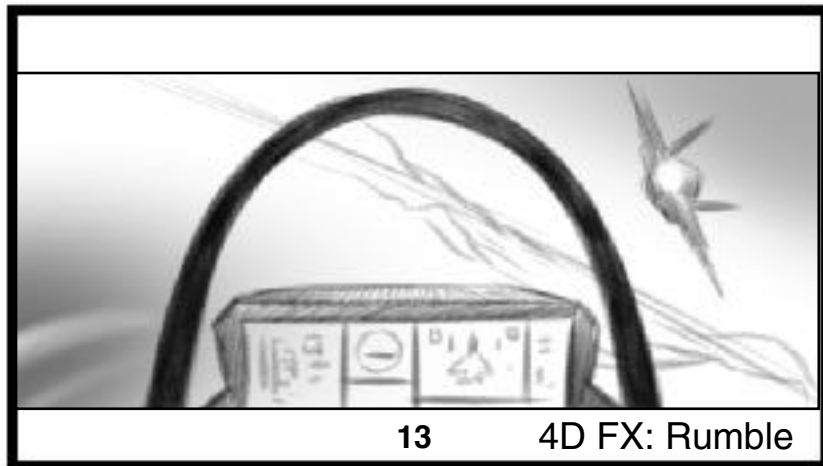

COMMANDER: Hunter One-Niner, I have activated Space and Cyber Comms for support and a recon plane is in route with intel on the location of the hostages.

PILOT: Roger that

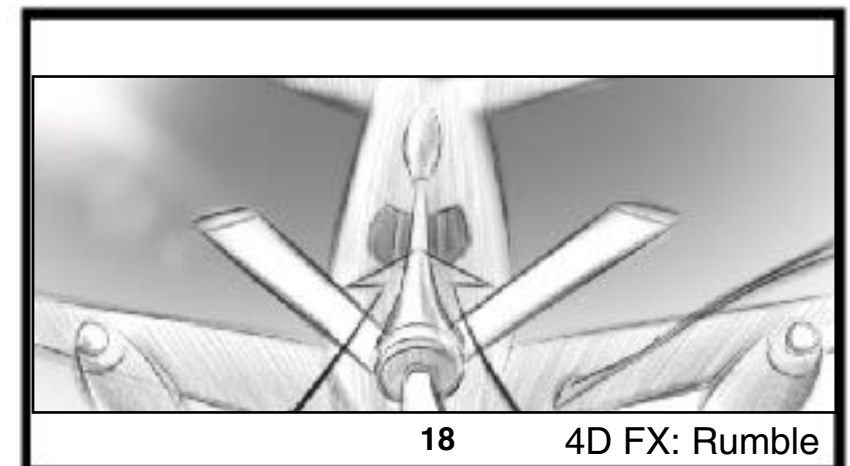
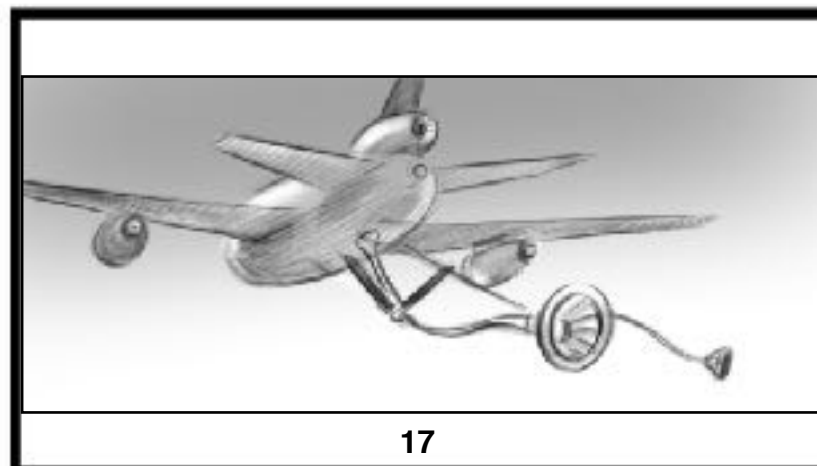
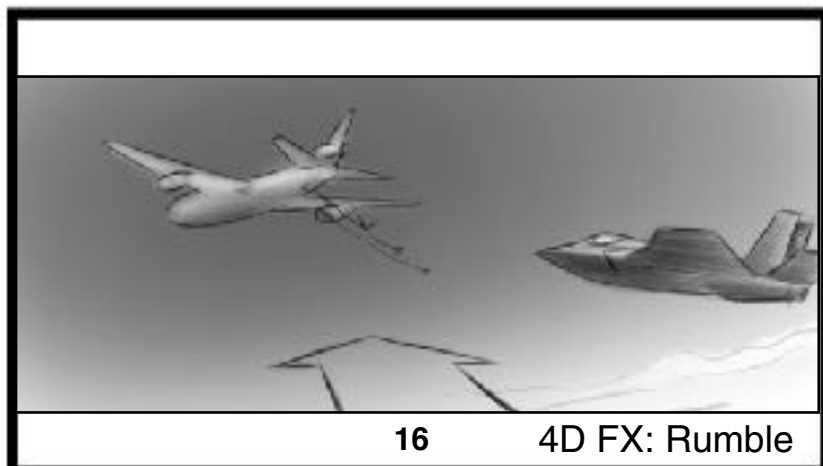

PILOT: This is Hunter One-Nine. Request to rejoin.

TANKER: You are cleared for contact, Hunter One-Nine.

CONNECT!

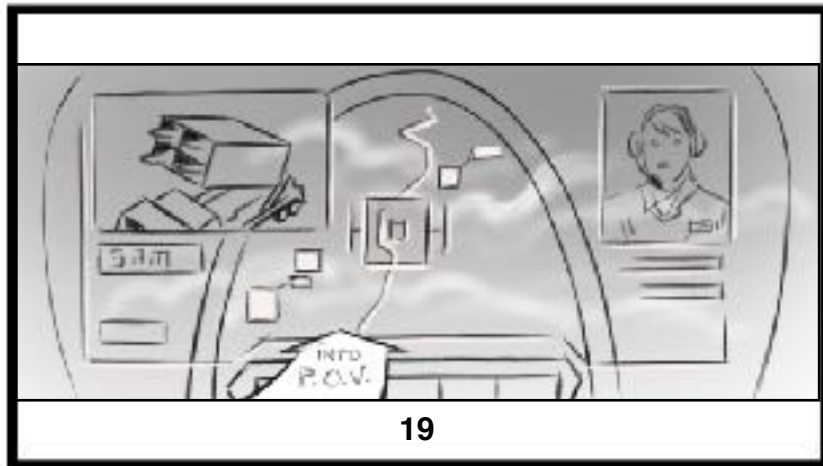

19

...as a CRYPTOLOGIC LANGUAGE ANALYST appears on our HUD SCREEN.

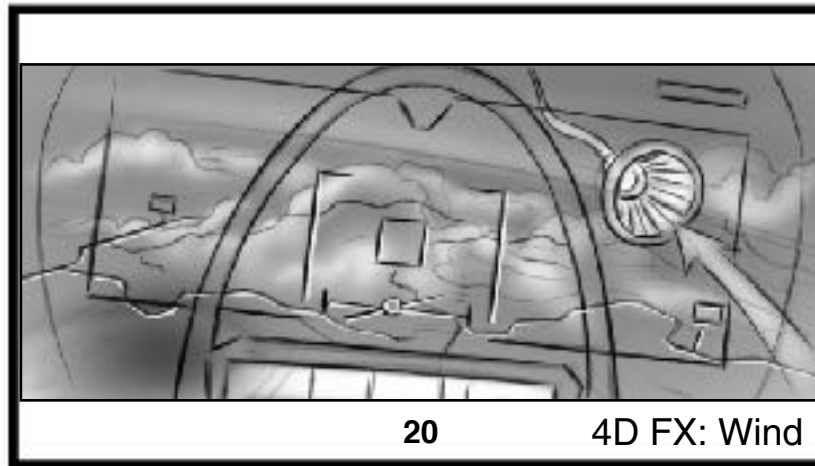

20

4D FX: Wind

The BOOM detaches—RUMBLE EFFECTS jostling us hard—as we disconnect from the KC-10 and descend back through clouds to reveal...

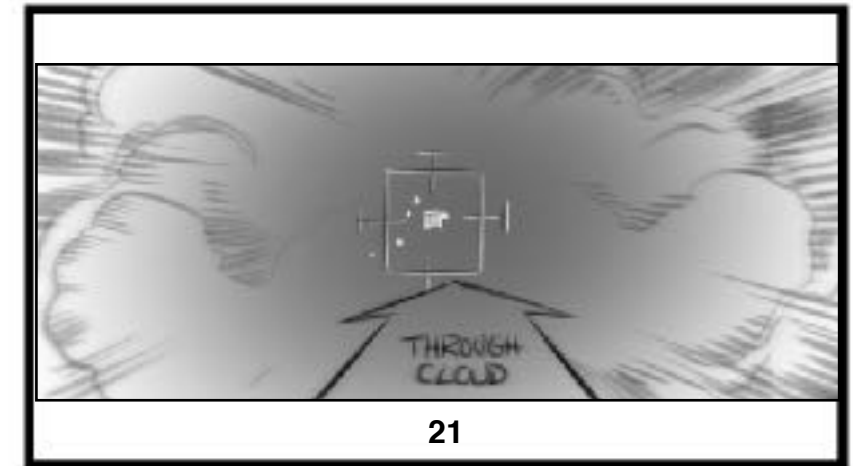

21

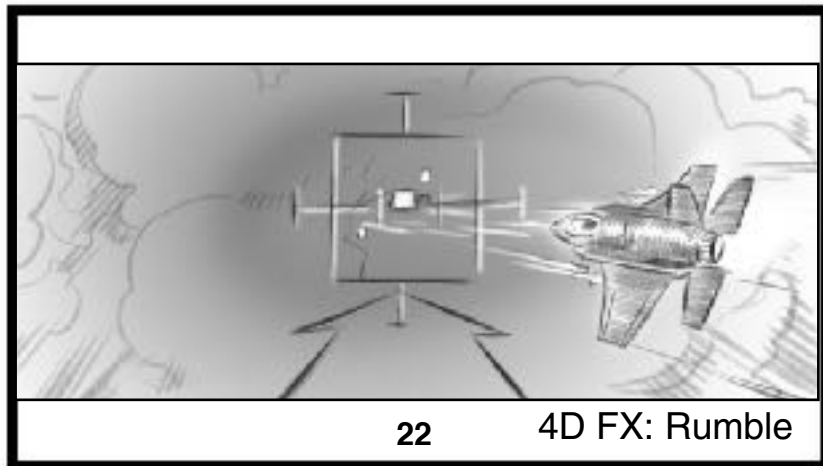

22

4D FX: Rumble

PILOT: I have eyes on target.

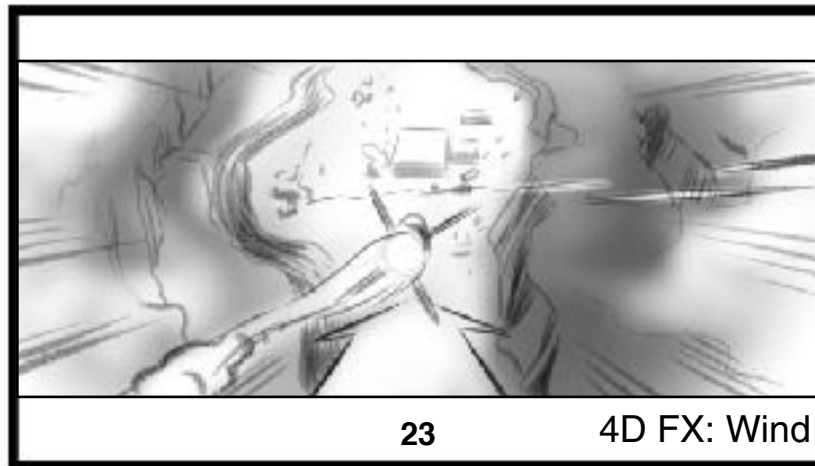

23

4D FX: Wind

COMMANDER: Hunter One-Nine, you are cleared hot.



24

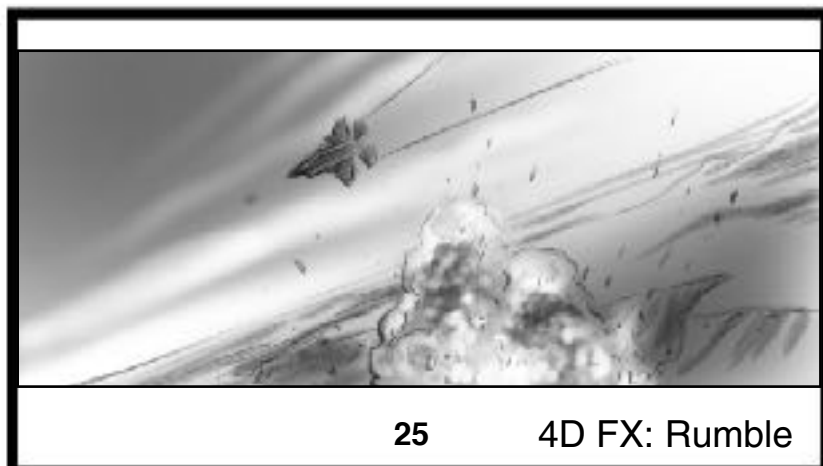

25

4D FX: Rumble

...during a series of extreme maneuvers, fly around the compound evading enemy fire while taking out the enemy's gun turrets.

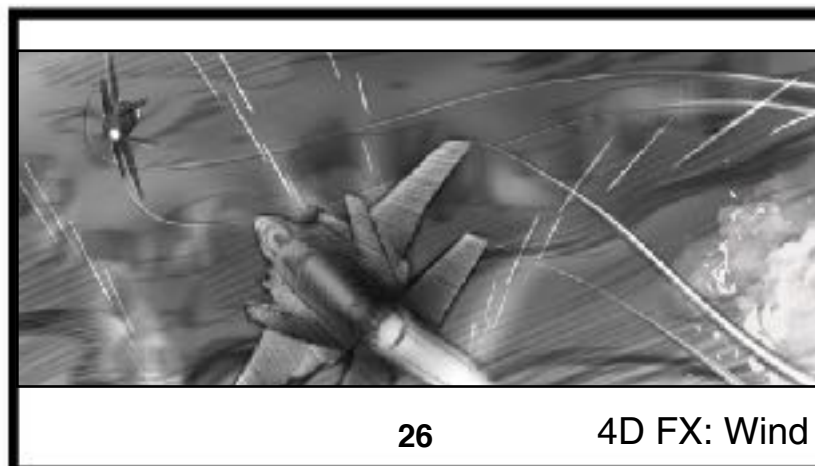

26

4D FX: Wind

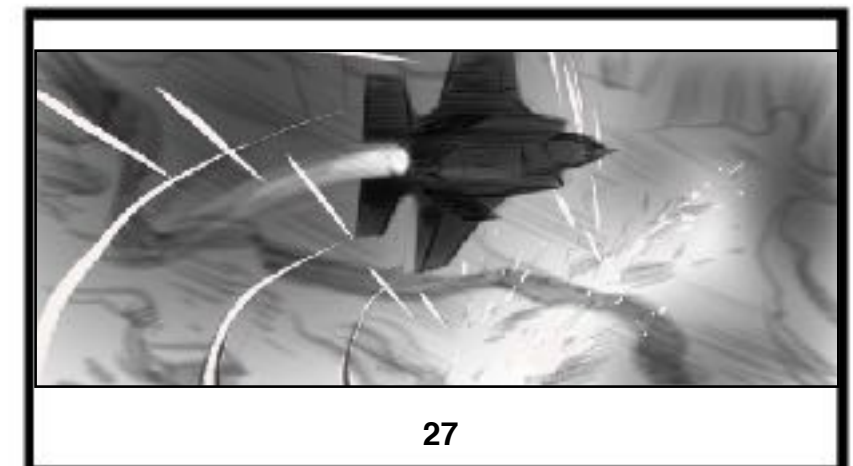

27

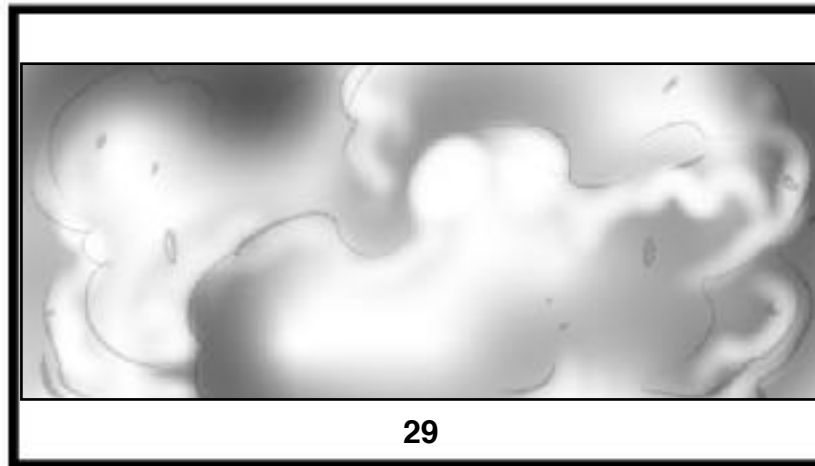
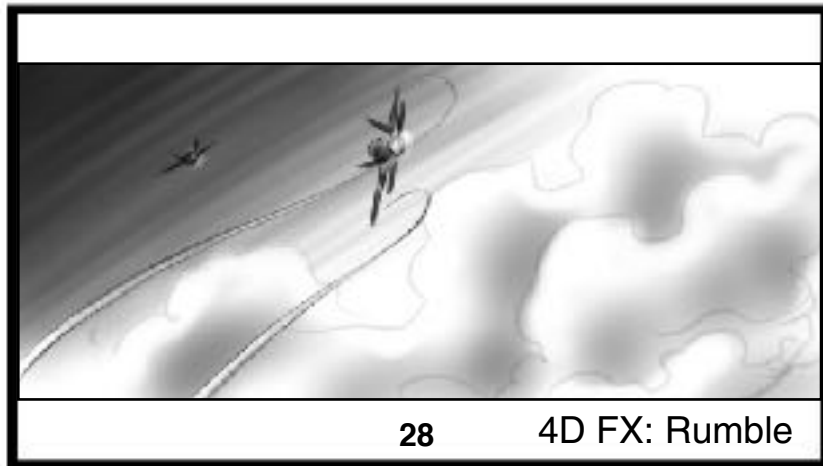

We fly into the clouds and...

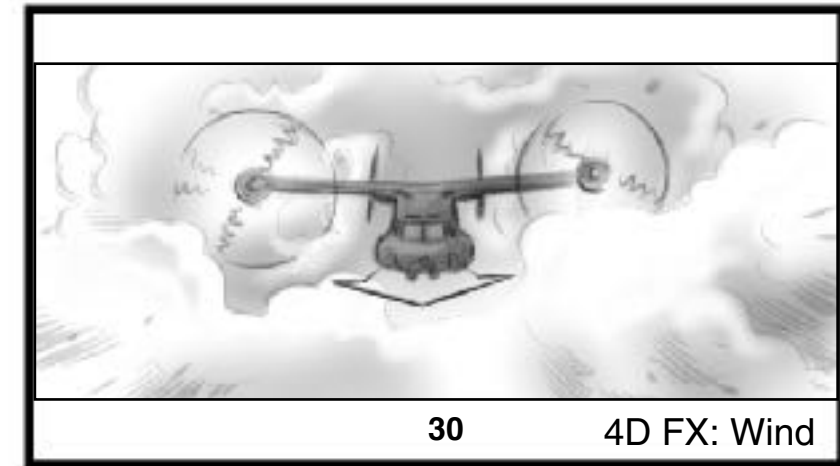

A CV-22 OSPREY emerging out of SMOKE and FOG...

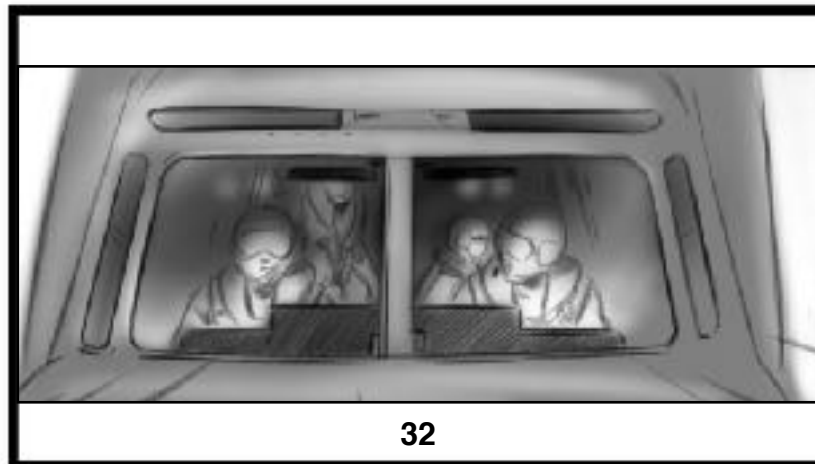
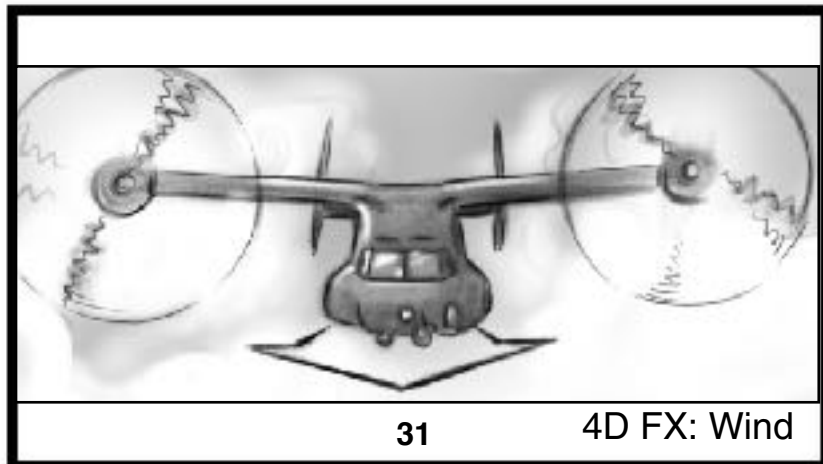

Inside THE COCKPIT of the OSPREY – continuing into the plane's hull...

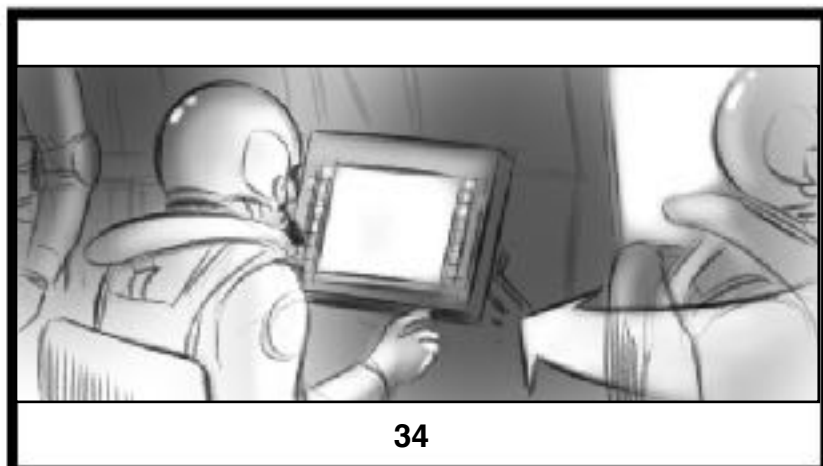
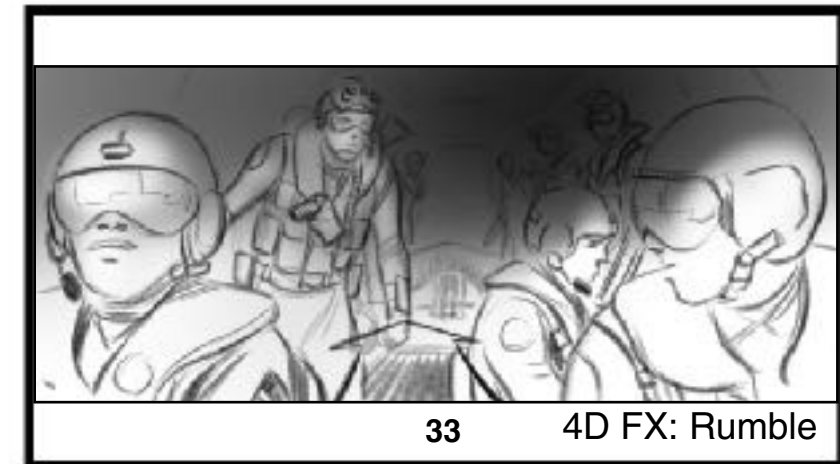

...we see an Airman looking intently into a BLUE FORCE TRACKER of the ENEMY COMPOUND.

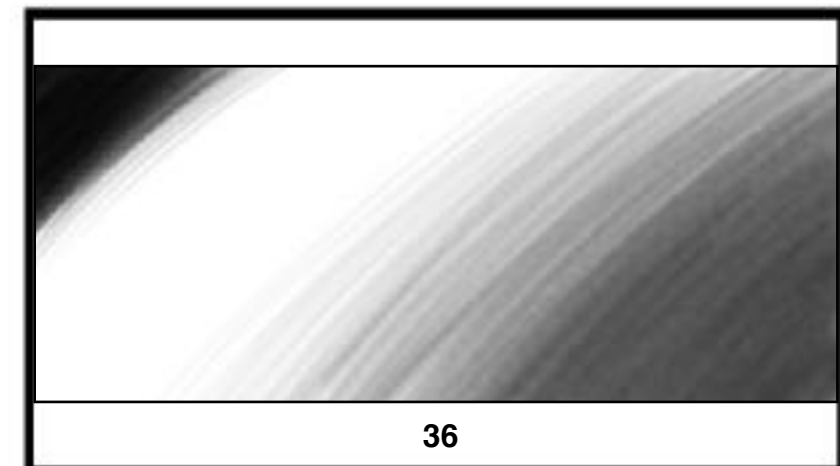
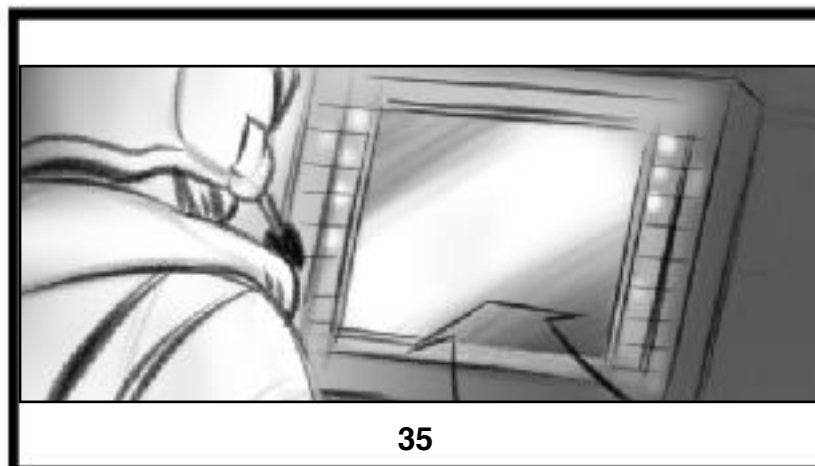

SPACE, —everything SILENT—until a USAF satellite sails toward us.

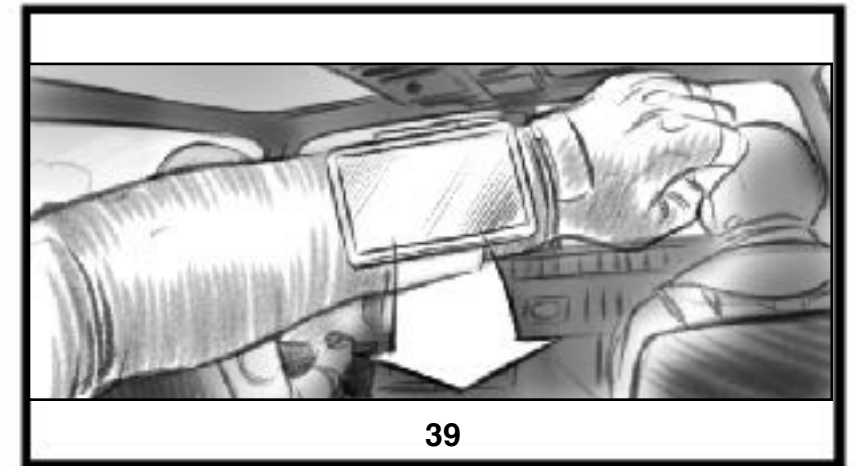
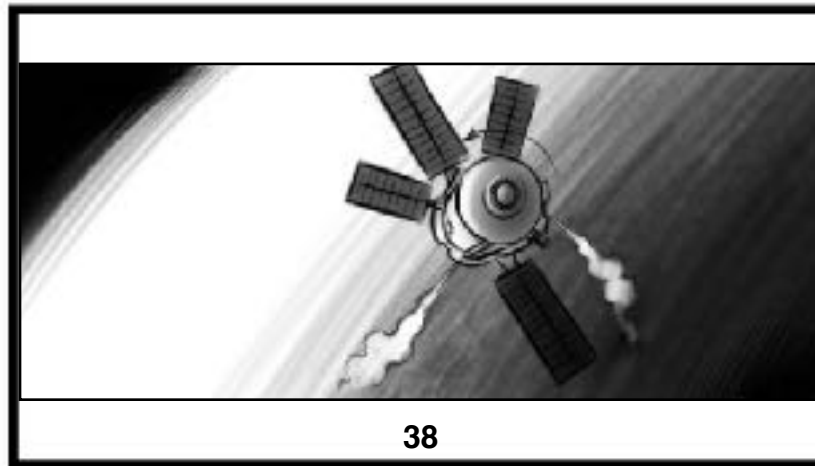
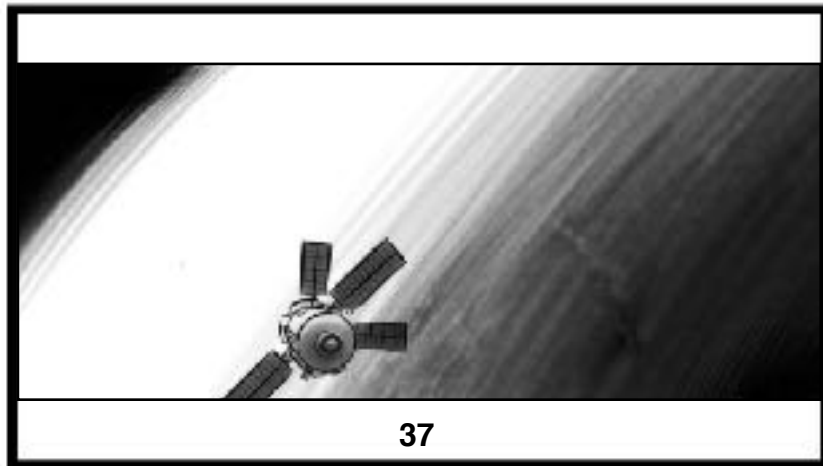

SPACE COMMAND: Commencing with orbital adjustment. Once in position you will have visual.

The screen breaks up and comes back into view showing a blue force tracker of the enemy compound...

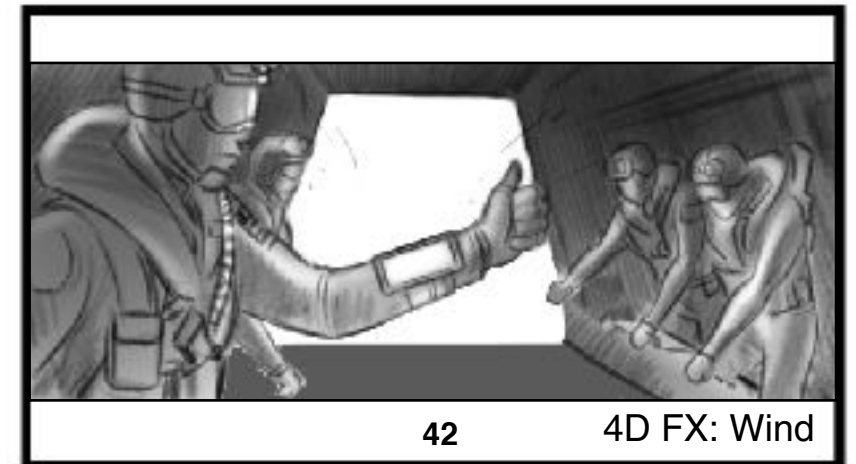
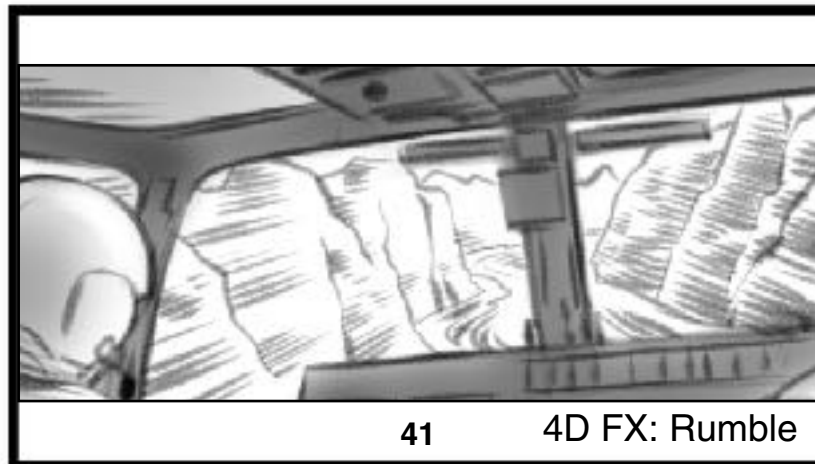
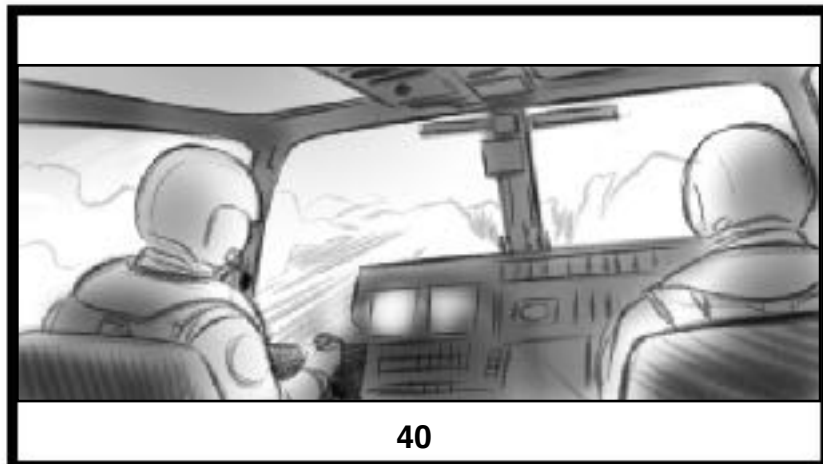

...we see it flying low over a forested terrain. When the forest gives way to an OPEN CANYON...

CV-22 PILOT: This is Raven Three-One. We are wheels up with four Eagles. Requesting target update.

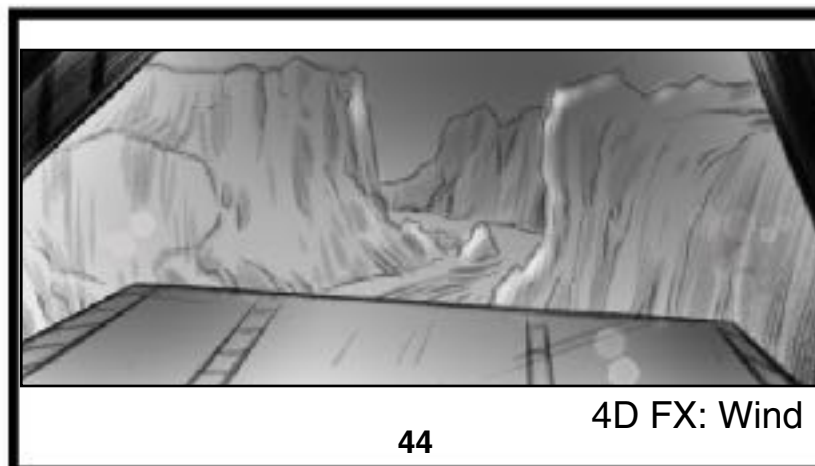
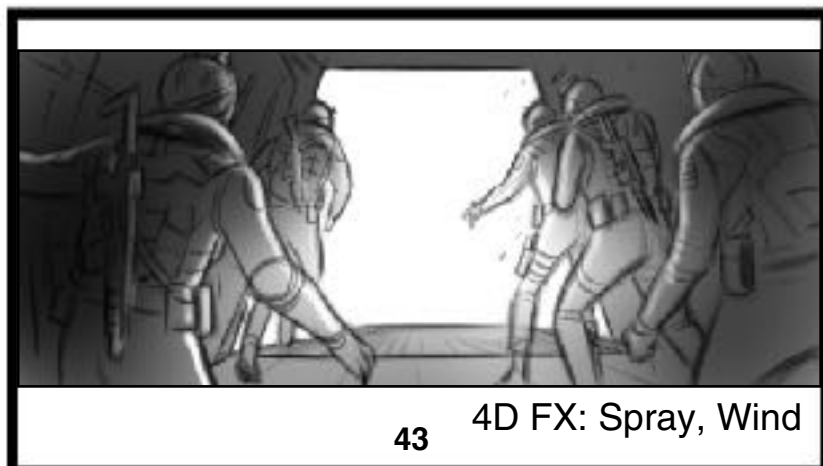

We jump feet first into the dark waters...

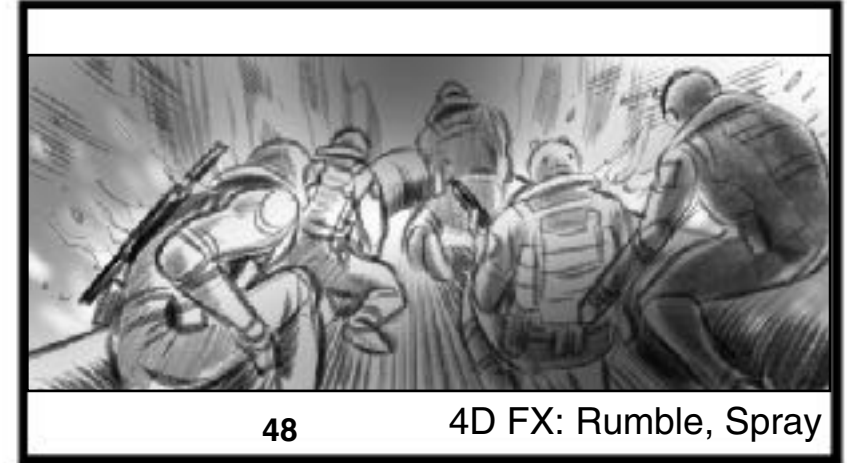
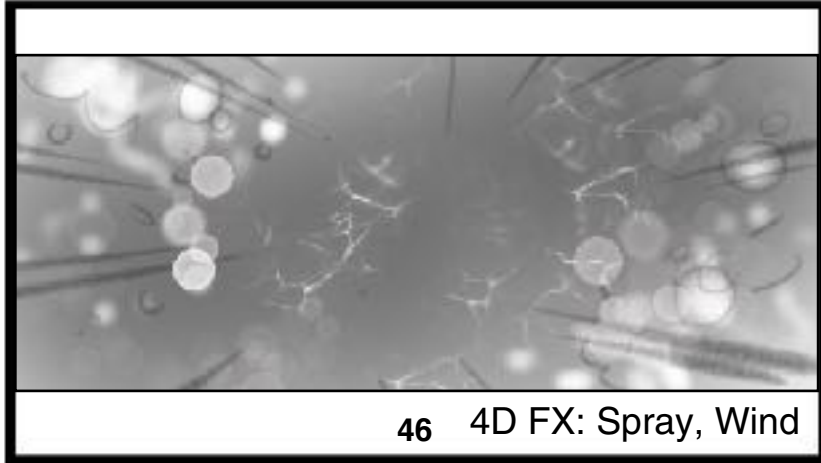

Our TEAM LEADER takes over the outboard motor...

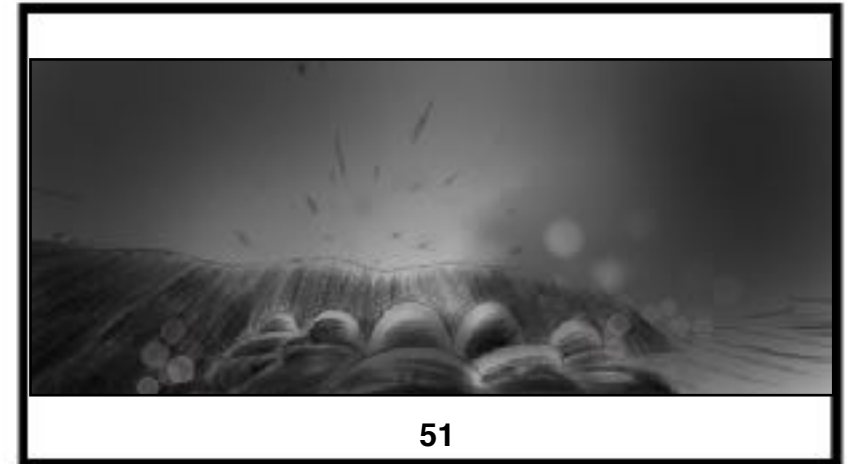
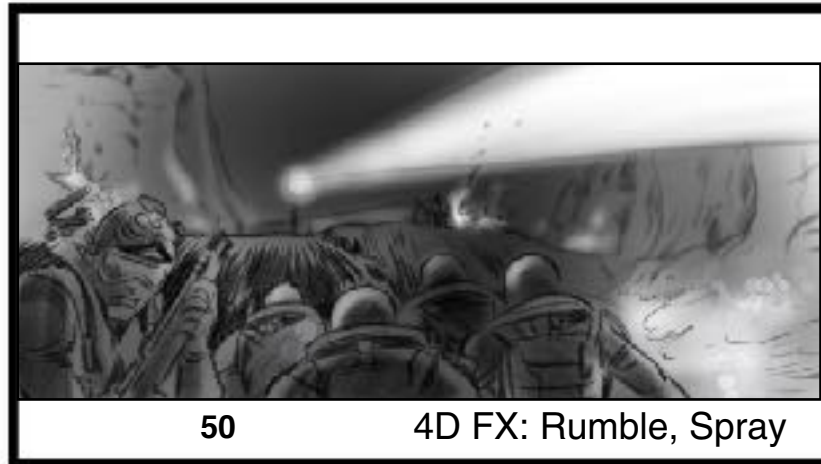
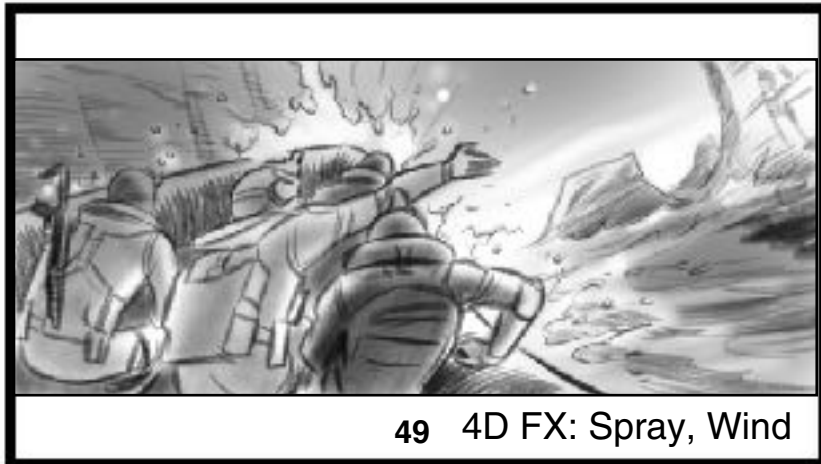

Finally, THE COMPOUND comes into sight...

SPEC OPS: ...We need to cut the electrical grid within a five-kilometer radius.

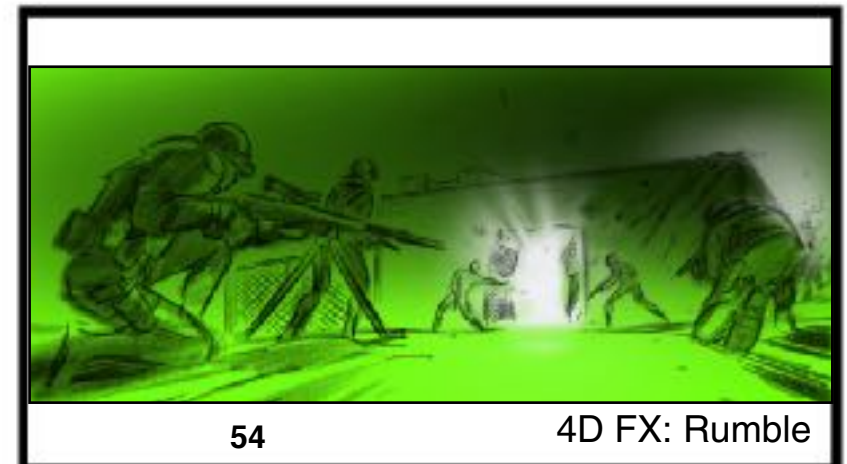
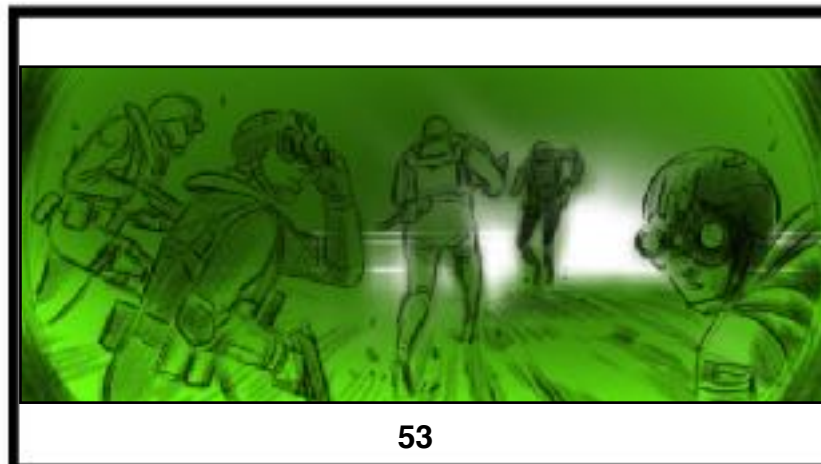
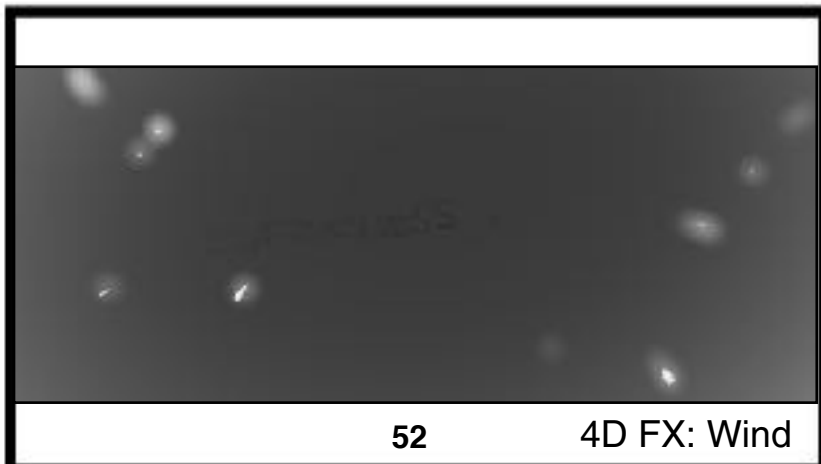

COMMANDER: Copy that, Shadow Four-Four. Cyber Command is on it. Stand by...

SPEC OPS: Go! Go! Go!

...BOOM. A door to the COMPOUND blows open



55

THE HOSTAGES being led outside by our SPECIAL OPS TEAM....

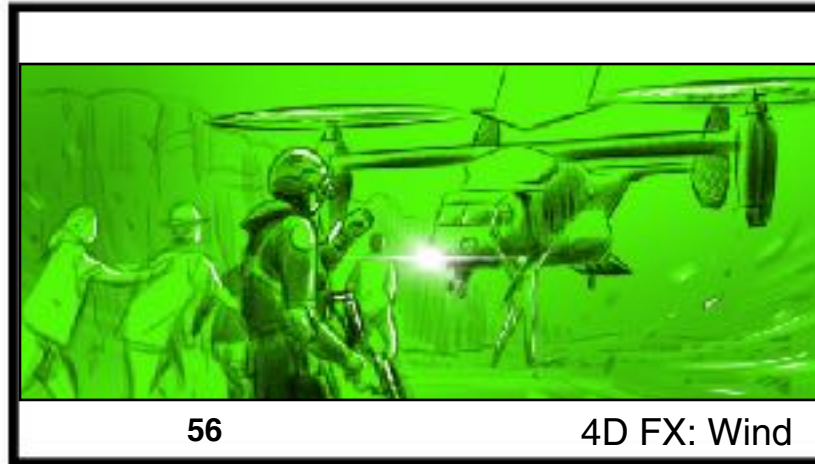

56

4D FX: Wind

... towards the CV-22 hovering just off the ground...

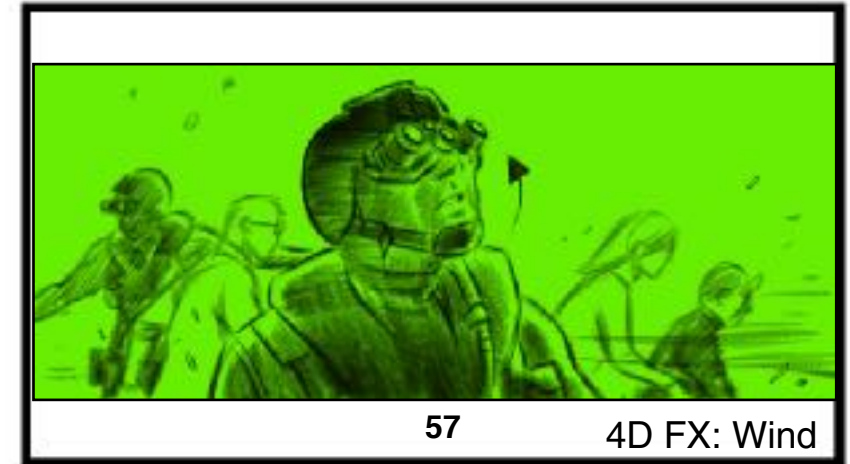

57

4D FX: Wind

SPEC OPS: Hostages are secured, Hunter One-Nine. You are cleared off.

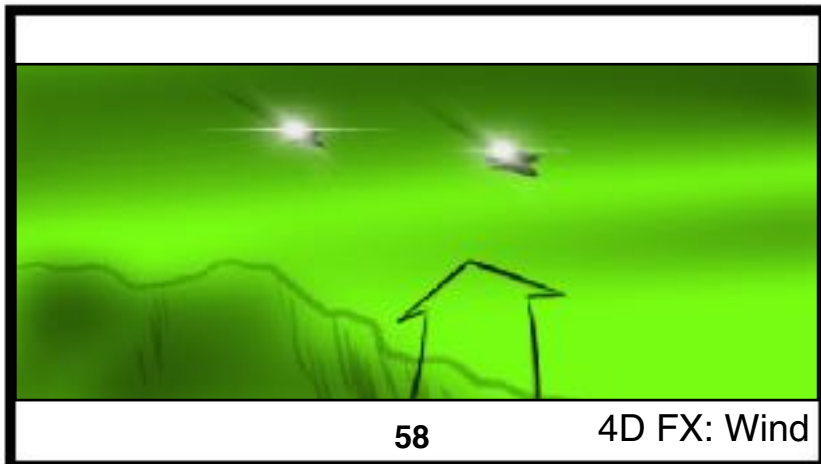

58

4D FX: Wind

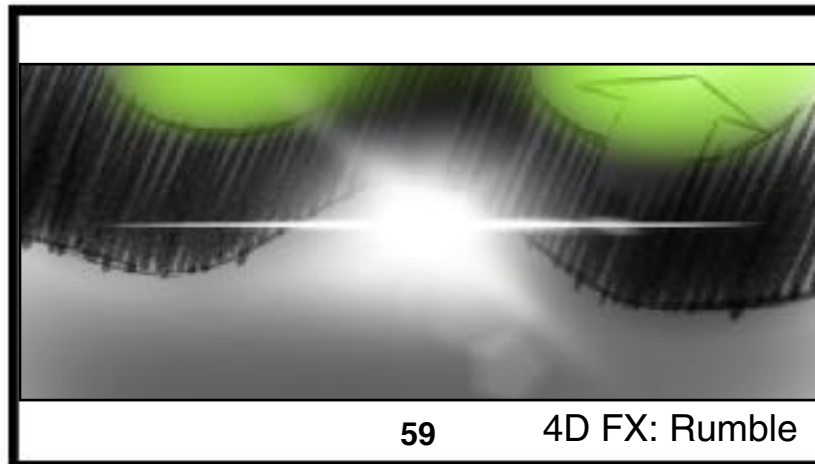

59

4D FX: Rumble

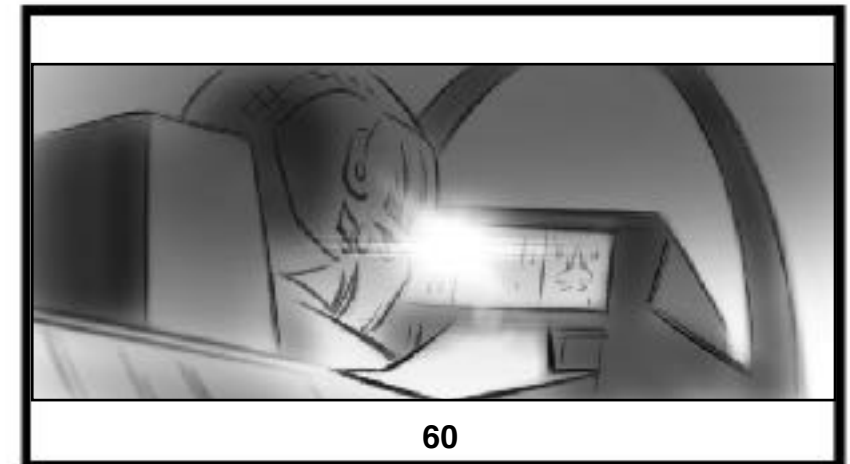

60

PILOT: Roger that. Let's head home...

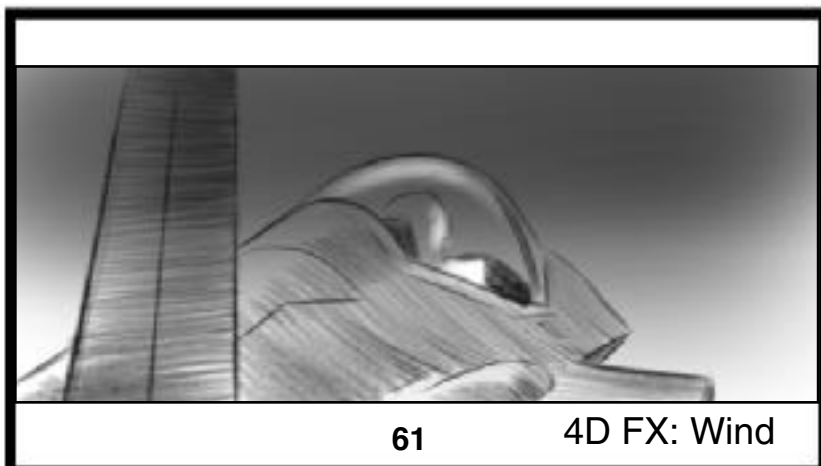

61

4D FX: Wind

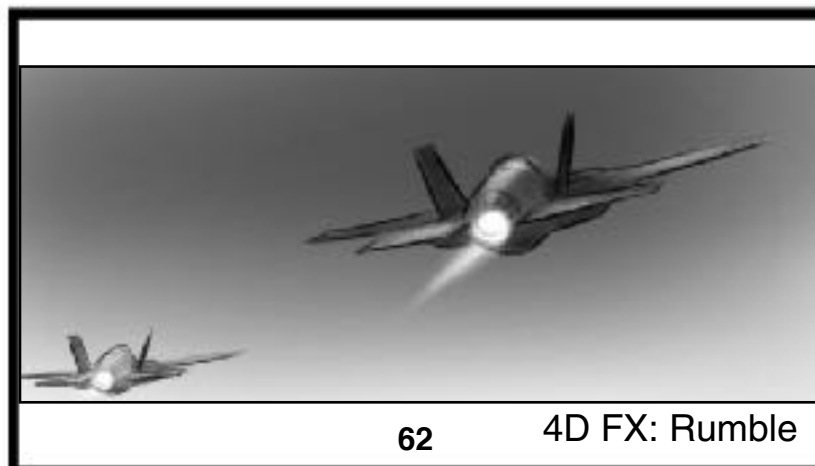

62

4D FX: Rumble

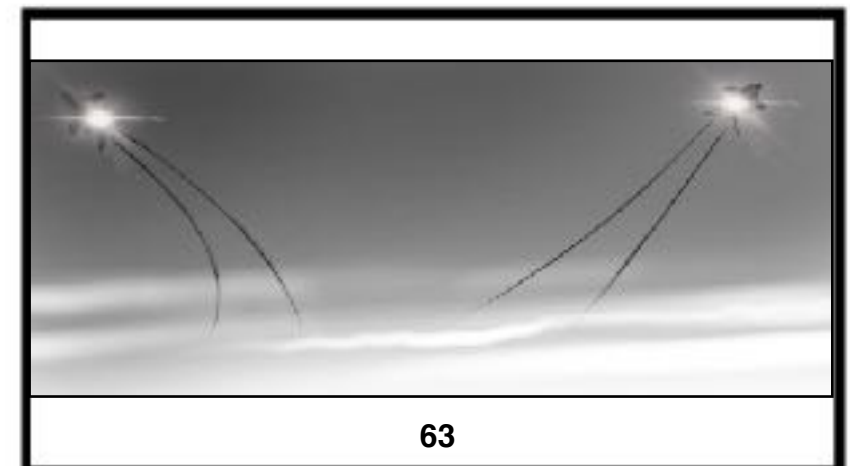

63

